

BI-30U/O



**FEATURES**

- Monitor and control remotely with Wi-Fi connectivity

---

- Accepts custom panels for an integrated look within cabinetry or stainless-steel accessory panels and handles to match other Sub-Zero, Wolf, and Cove products\*

---

- Preserves refrigerated foods with cool, moist air and frozen foods with frigid, dry air

---

- Fight spoilage and odours with a NASA-inspired air purification system

---

- Locks in cold air to ensure freshness with magnetic door seals

---

- Keeps produce fresher with high-humidity, sealed crisper and deli drawers

---

- Controls temperature within one degree of setpoint

---

- Filters ice, removing contaminants, chlorine taste, and odour

---

- Yields ice automatically and “max ice” for additional production

---

- Ensures excellent visibility with bright lights

---

- Refer to freshness cards for tips on food preservation, use, and care

**ACCESSORIES**

- Air Purification Cartridge

---

- Egg Container

---

- Legacy Dual Installation Kit

---

- Legacy Pro Handle

---

- Legacy Pro Handle

---

- Legacy Stainless Steel Flush Inset Door Panel with Pro Handle

---

- Legacy Stainless Steel Flush Inset Door Panel with Tubular Handle

---

- Legacy Stainless Steel Flush Inset Drawer Panel with Pro Handle

---

- Legacy Stainless Steel Flush Inset Drawer Panel with Tubular Handle

---

- Legacy Stainless Steel Kickplate

---

- Legacy Stainless Steel Pro Louvered Grille - 84"

---

- Legacy Stainless Steel Side Panel

---

- Legacy Tubular Handle

---

- Legacy Tubular Handle

---

- Stainless Steel Dual Flush Inset Door Panel with Pro Handle

---

- Stainless Steel Dual Flush Inset Door Panel with Tubular Handle

---

- White Side Panel

Accessories are available through an authorized dealer. For local dealer information, visit [subzero-wolf.com/locator](http://subzero-wolf.com/locator).



**HANDLE ACCESSORIES**

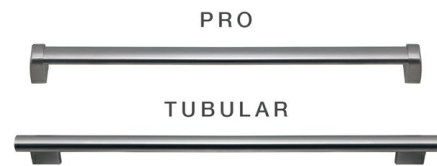

**PRODUCT DETAILS**

**REFRIGERATOR**

- LED refrigerator and freezer lights
- 4 glass refrigerator shelves (3 adjustable; 1 stationary)
- 1 high-humidity crisper drawer with adjustable dividers
- 1 deli drawer with adjustable dividers
- 3 door bins (2 adjustable; 1 stationary)
- 1 adjustable dairy compartment

**FREEZER**

- Full-extension roll-out freezer drawer
- Automatic ice maker with removable ice container

**PRODUCT SPECIFICATIONS**

Model	BI-30U/O
Dimensions	30"W x 84"H x 24"D
Refrigerator Capacity	12.9 cu. ft.
Freezer Capacity	4.1 cu. ft.
Electrical Supply	115 VAC, 60 Hz
Electrical Service	15 amp dedicated circuit
Plumbing Supply	1/4" OD copper, braided stainless steel or PEX tubing
Plumbing Pressure	35–120 psi
Receptacle	3-prong grounding-type

**ELECTRICAL**

**PLUMBING**

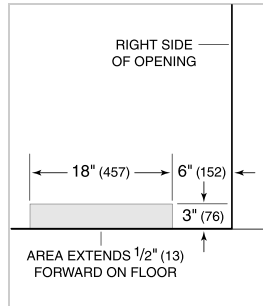
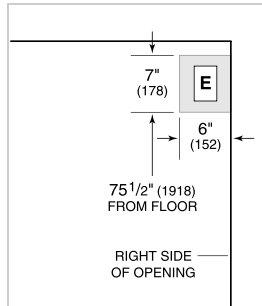

**PANEL SPECIFICATIONS** For complete panels specifications including width/height, weight requirements, thickness requirements and offset details visit [subzero-wolf.com/builtinconfigurator](http://subzero-wolf.com/builtinconfigurator).

**NOTE:** Dimensions in parenthesis are in millimeters unless otherwise specified

**INTERIOR VIEW**

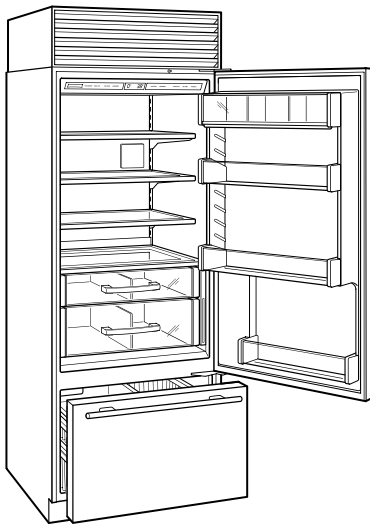

This illustration is intended for interior reference only and may not represent the exterior of the model being specified.

**DIMENSIONS**

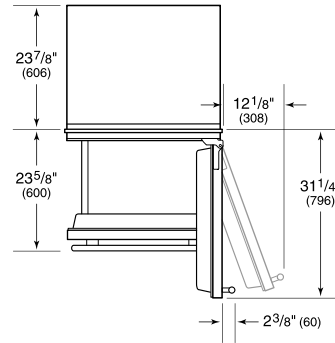
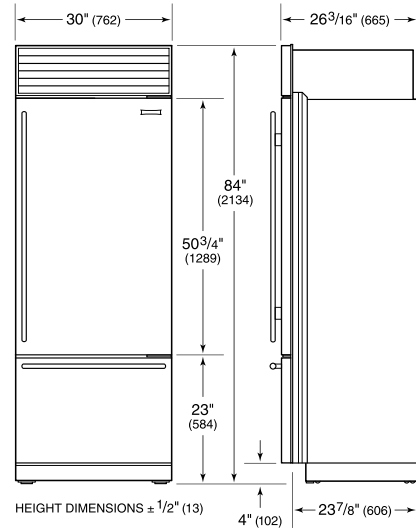

**FLUSH INSET INSTALLATION**

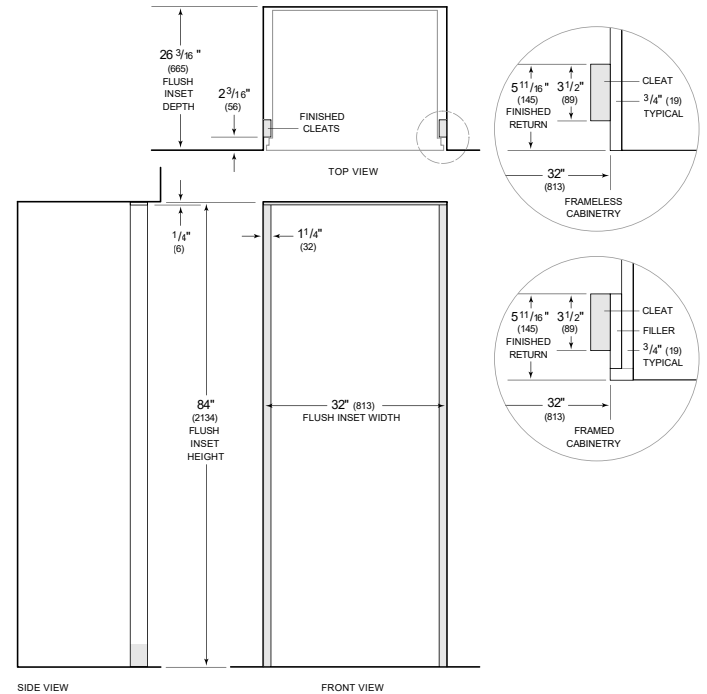

**NOTE:** 3/2" (89) finished returns and shaded areas will be visible and should be finished to match cabinetry. Shaded line represents profile of unit with 1/4" (19) panel.