

**EC2450TE/S**

**FEATURES**

- Intuitive touchscreen
- Save favorites within six independent user profiles
- Easy beverage customization
- Over 15 different beverage options
- Insulated milk container with froth regulator
- Professional-style whole bean burr grinder with stainless steel burrs
- Large water tank
- Height-adjustable, dual dispensing coffee spout
- Cleaning and rinse container
- Storage
- Installation made simple
- Coordinates with other Sub-Zero and Wolf appliances
- Ensured dependability

**ACCESSORIES**

- Care Kit
- Charcoal Filter
- Descaling Solution
- Insulated Milk Container

Accessories available through an authorized dealer.  
For local dealer information, visit [subzero-wolf.com/locator](http://subzero-wolf.com/locator).



**PRODUCT SPECIFICATIONS**

Model	EC2450TE/S
Dimensions	23 1/2"W x 17 7/8"H x 19"D
Weight	67 lbs
Electrical Supply	120 VAC, 60 Hz
Electrical Service	15 amp dedicated circuit
Power Cord Length	6 Feet
Receptacle	3-prong grounding-type

**ELECTRICAL**

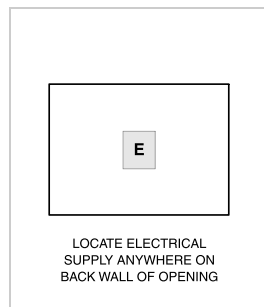

**NOTE:** Dimensions in parenthesis are in millimeters unless otherwise specified

**DIMENSIONS**

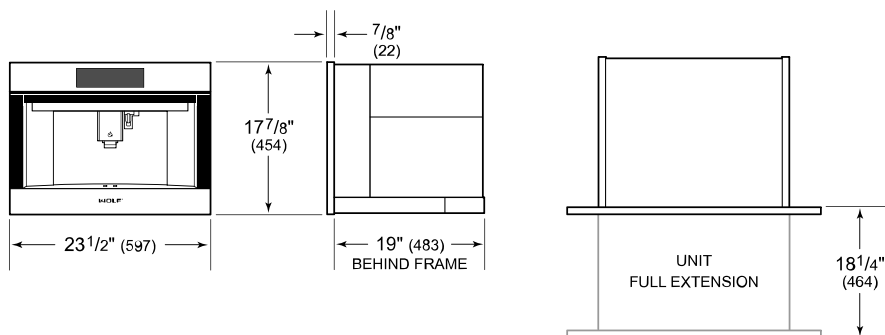

**STANDARD INSTALLATION**



**NOTE:** 24" (610) model and 30" (762) model require the same opening dimensions.