

DF48650C/S/P



FEATURES

Patented dual-stacked, sealed burners offer precise temperature adjustment

Burners produce up to 20,000 Btu for fast boils and intense sears and as low as 300 Btu for true simmers and melts

For improved temperature control and safety, the spark ignition system reignites burners automatically

Wolf's Dual VertiFlow™ convection system provides reliably even heat, reduces hot and cold spots, and enables consistent multi-rack cooking

Gourmet Mode features nearly 50 presets that automatically control the oven to ensure delicious results

Take the guesswork out of cooking with 10 chef-created cooking modes, including Bake, Broil, Convection, Convection Roast, Dehydrate, Gourmet, Proof, Roast, Stone, and Warm

The adjustable 16,000 Btu infrared charbroiler features high and low settings, aptly handling a range of foods from steaks and burgers to delicate fish fillets and vegetables

The full-color touchscreen is intuitive and easy to read, discreetly hiding away when not in use

LED backlit control bezels illuminate when in use, indicating which burners are active

The oven offers self-clean, delayed start, timed cook, and Sabbath features

The temperature probe alerts you when your dish has reached the desired temperature

Control your range from wherever you are using our convenient Owner's App—remotely preheat, adjust temperatures, select modes, and more

ACCESSORIES

18" Broiler Pan

18" Dehydration Rack Set

18" Full-Extension Ball-Bearing Oven Rack

18" Standard Oven Rack

2-Burner Wok Grate

30" Broiler Pan

30" Dehydration Rack Set

30" Full-Extension Ball-Bearing Oven Rack

30" Premier Baking Sheet

30" Standard Oven Rack

48" and 60" Dual Fuel Brushed Brass Bezel Kit

Bake Stone Kit

Filler Trim

Temperature Probe

Red, black, brushed stainless, brushed brass, and brushed gray knob kits

Rear Caster Covers



KNOB OPTIONS



TOP CONFIGURATION

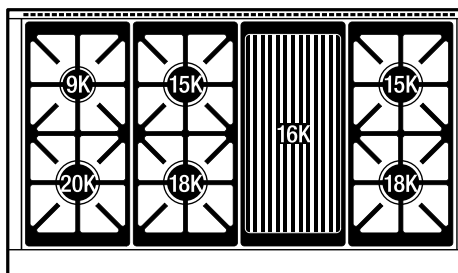

RANGETOP SPECIFICATIONS

- 1 - 9,200 Btu burner
- 2 - 15,000 Btu burners
- 2 - 18,000 Btu burners
- 1 - 20,000 Btu burner
- 1 - 16,000 Btu charbroiler
- Stainless-steel charbroiler cover
- Stainless-steel island trim

Front Leg Extension Covers

Stainless Steel Kickplates

5" and 10" stainless steel risers, and 20" riser with shelf

Accessories available through an authorized dealer.

For local dealer information, visit subzero-wolf.com/locator.

Specifications are subject to change without notice. This information was generated on May 24, 2024. Verify specifications prior to finalizing your cabinetry/enclosures.

PRODUCT SPECIFICATIONS

Model	DF48650C/S/P
Dimensions	47 7/8"W x 36 1/2"H x 29 1/2"D
Oven 1 Interior Dimensions	25 1/4"W x 17 1/2"H x 20"D
Oven 2 Interior Dimensions	13 1/4"W x 17 1/2"H x 19 3/4"D
Oven 1 Usable Capacity	1.8 cu. ft.
Oven 1 Overall Capacity	2.7 cu. ft.
Oven 2 Usable Capacity	3.2 cu. ft.
Oven 2 Overall Capacity	5.1 cu. ft.
Door Clearance	21"
Electrical Supply	240/208 VAC, 60 Hz
Electrical Service	50 amp dedicated circuit
Gas Supply	3/4" ID line
Gas Inlet	1/2" NPT female

ELECTRICAL

GAS



NOTE: Dimensions in parenthesis are in millimeters unless otherwise specified

DIMENSIONS

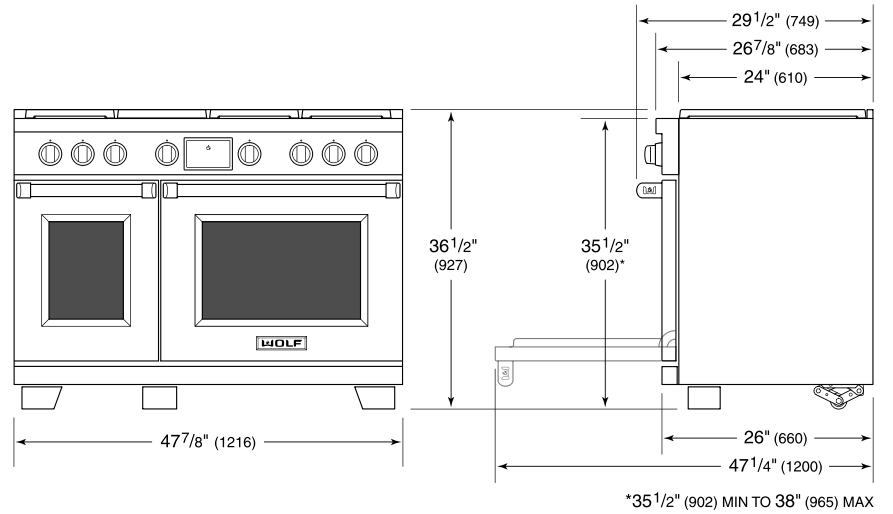

STANDARD INSTALLATION

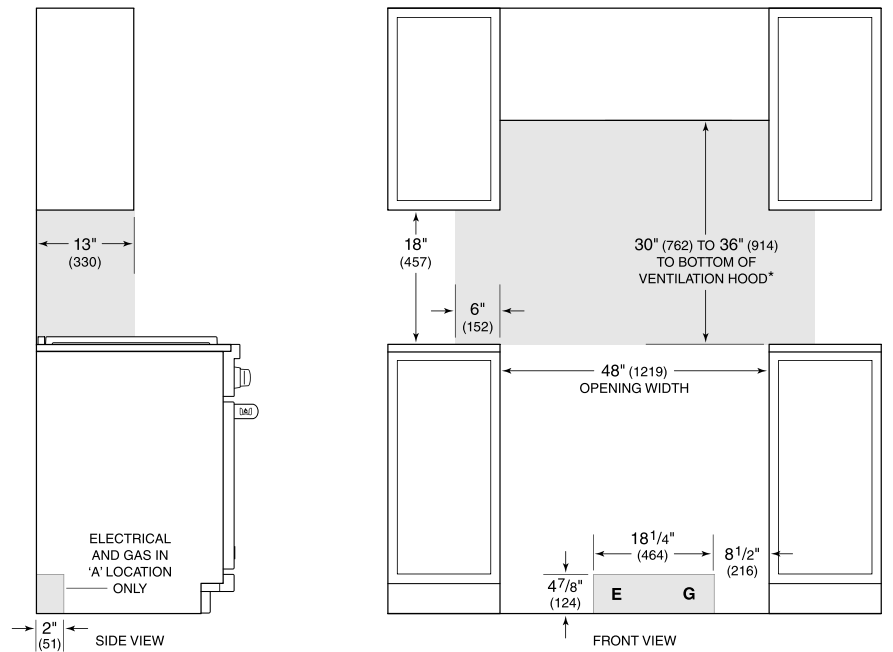

**Without ventilation hood, 36" (914) minimum clearance countertop to combustible materials, 44" (1118) for charbroiler.*

NOTE: Shaded area above countertop indicates minimum clearance to combustible surfaces, combustible materials cannot be located within this area.

For island installation, 12" (305) minimum clearance back of range to combustible rear wall above countertop.