

SO3050TE/S/T



FEATURES

Wolf's dual convection system featured in the upper oven provides reliably even heat, reduces hot and cold spots, and enables consistent multi-rack cooking

Ten cooking modes, including Bake, Broil, Convection, Convection Roast, Dehydrate, Gourmet, Proof, Roast, Stone, and Warm, were developed by Wolf chefs to maximize the performance of your oven

Gourmet Mode offers nearly 50 presets to automatically cook a delicious set of impressive dishes

The large full-color touch screen and stainless touch controls are intuitive and easy-to-read

Temperature Probe

The oven offers self-clean, delayed start, timed cook, and Sabbath features

The oven's Wi-Fi enabled feature lets you remotely preheat, select modes, and adjust oven temperature from your mobile device

Coordinates with other [#tri-brand#] appliances to create a cohesive look in your kitchen

Get the most out of your oven with tips and recipes from the Mastering the E Series Oven guide

ACCESSORIES

30" Broiler Pan

807143-30" Bake Stone Kit

Bake Stone Kit

Baking Sheet

Dehydration Kit

Dehydration Rack Set

Dual Installation Kit

Full-Extension Ball-Bearing Rack

Premier Baking Sheet

Standard Oven Rack

Temperature Probe

Accessories available through an authorized dealer.

For local dealer information, visit subzero-wolf.com/locator.



PRODUCT SPECIFICATIONS

Model	SO3050TE/S/T
Dimensions	29 7/8"W x 28 1/2"H x 23"D
Oven 1 Interior Dimensions	25 1/4"W x 17 1/2"H x 18 1/2"D
Overall Capacity	4.7 cu. ft.
Usable Capacity	3.1 cu. ft.
Door Clearance	21 3/8"
Weight	257 lbs
Electrical Supply	240/208 VAC, 60 Hz
Electrical Service	30 amp dedicated circuit
Conduit Length	4 Feet

DIMENSIONS

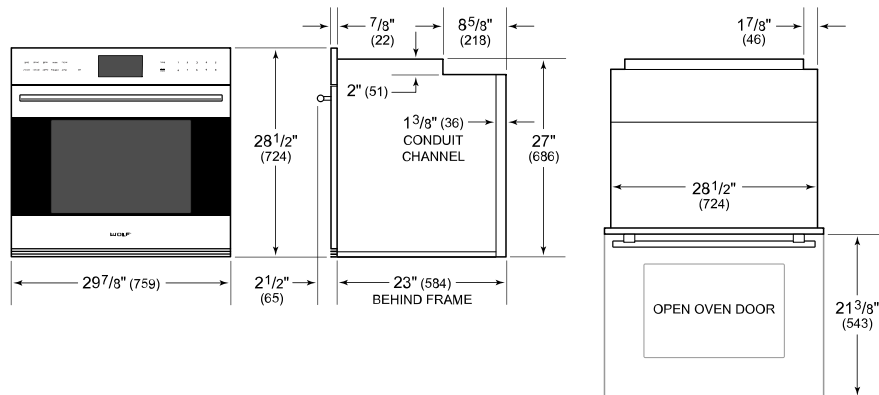

ELECTRICAL

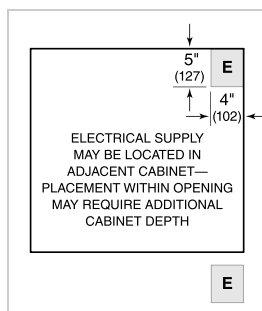

NOTE: Dimensions in parenthesis are in millimeters unless otherwise specified

FLUSH INSTALLATION

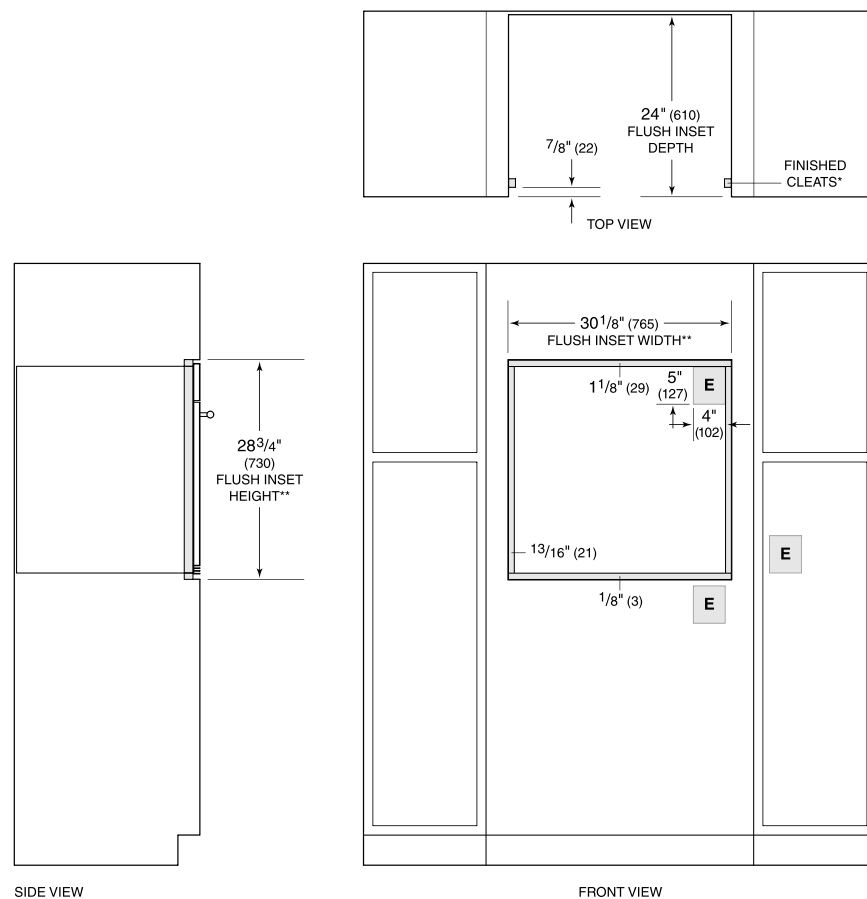

*Shaded areas will be visible and should be finished to match cabinetry.

**Dimension provides minimum reveals.

NOTE: Location of electrical supply within opening may require additional cabinet depth.