

MD30TE/S

FEATURES

Utilize 950 watts of power to cook meals with delicious results

Select from 10 power levels, a warming mode, and sensor cooking

Let the microwave do the cooking with intuitive Gourmet Mode settings

Fits a 9x13 pan and up to a 7" tall glass or dish for additional cooking flexibility

Install into surrounding cabinetry to coordinate with other Wolf built-in ovens and warming drawers

Installs can be lowered due to control panel lock providing extra safety

ACCESSORIES

Flush Inset Vent

Accessories available through an authorized dealer.

For local dealer information, visit subzero-wolf.com/locator.



PRODUCT SPECIFICATIONS

Model	MD30TE/S
Dimensions	29 7/8"W x 15 1/8"H x 21 7/8"D
Capacity	1.2 cu. ft.
Weight	96 lbs
Electrical Supply	120 VAC, 60 Hz
Electrical Service	15 amp dedicated circuit
Power Cord Length	4 Feet
Receptacle	3-prong grounding-type

ELECTRICAL

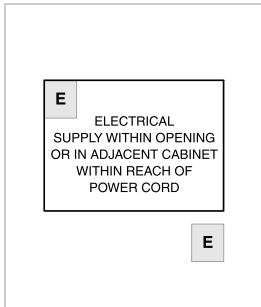

NOTE: Dimensions in parenthesis are in millimeters unless otherwise specified

DIMENSIONS

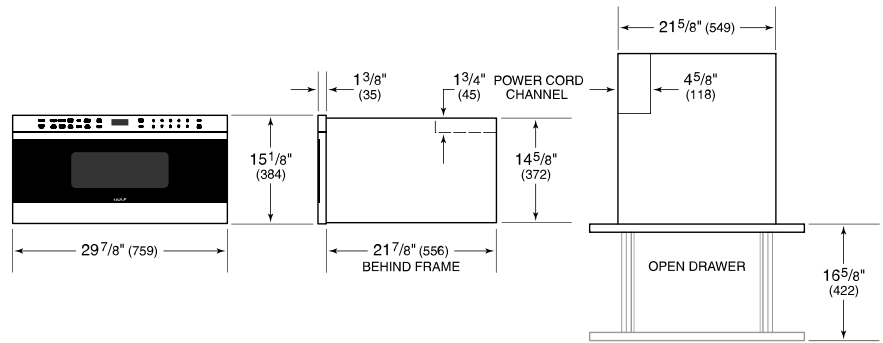

STANDARD INSTALLATION

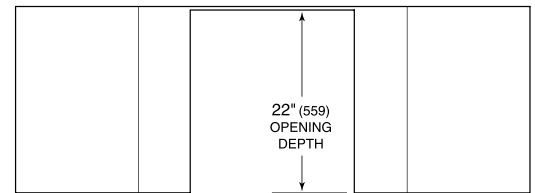

TOP VIEW

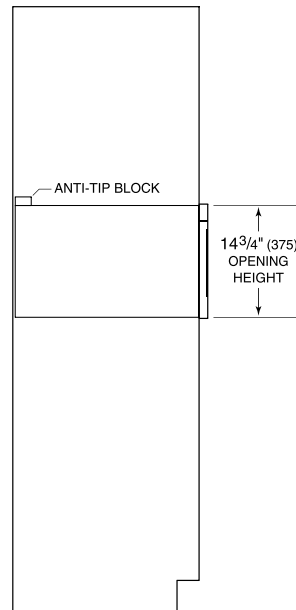

SIDE VIEW

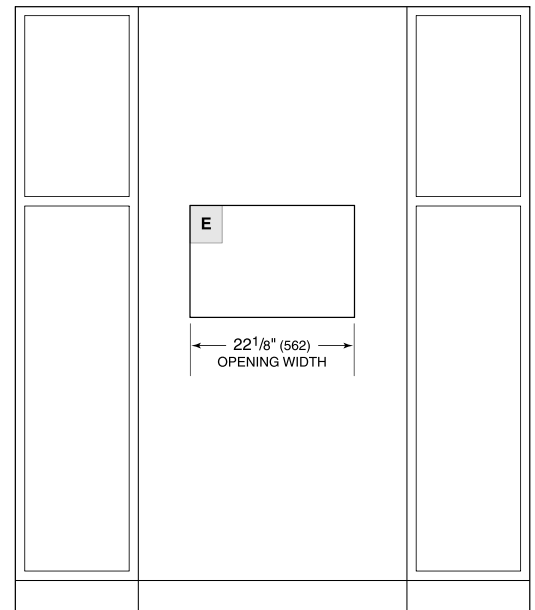

FRONT VIEW