

DD36

FEATURES

- _____Rigorously tested for decades of use
- _____Exceptional support from our Customer Care team in Madison
- _____Rises 14 inches to whisk away smoke and odors
- _____Lowers when not in use
- _____Heavy-gauge stainless steel
- _____Remote control operation from up to 9' away
- _____Blower required (internal, in-line or remote blowers available)
- _____Delay-off feature
- _____Delay-off feature shuts off blower after approximately 5 minutes
- _____Reversible motor box can be installed on either side of the downdraft
- _____Adjustable discharge lets you negotiate around ducting

ACCESSORIES

- _____10" Round Inline Damper
- _____1200 CFM Remote Blower
- _____600 CFM Internal Blower
- _____8" Round Inline Damper
- _____Contemporary Cooktop/Downdraft Trim
- _____Make-Up Air Damper
- _____Recirculating Filter
- _____Recirculating Kit
- _____SRT Downdraft Trim

Accessories available through an authorized dealer.
For local dealer information, visit subzero-wolf.com/locator.



BLOWER OPTIONS

- 600 CFM Internal
- 600 CFM Inline
- 600 CFM Remote
- 1200 CFM Remote

PRODUCT SPECIFICATIONS

Model	DD36
Dimensions	36"W x 14"H x 2"D
Weight	80 lbs
Electrical Supply	110/120 VAC, 60 Hz
Electrical Service	15 amp dedicated circuit
Discharge Location	Vertical or Horizontal
Discharge Dimensions	6" round internal or 10" round inline or remote
Receptacle	3-prong grounding-type

ELECTRICAL

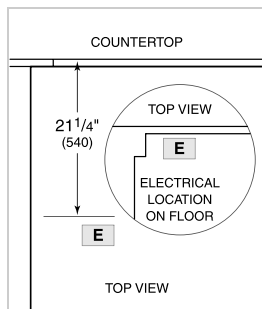

NOTE: Dimensions in parenthesis are in millimeters unless otherwise specified

DIMENSIONS

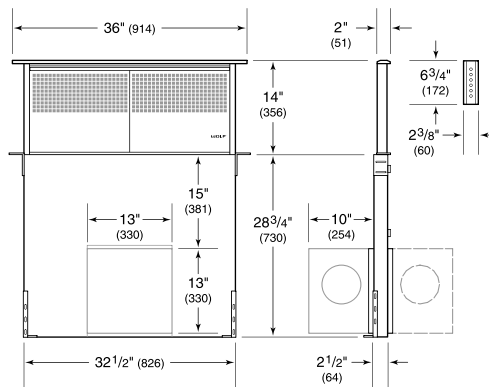

NOTE: Shown with front mounted internal blower with 6" (152) round discharge, dashed line represents rear mount.

STANDARD INSTALLATION

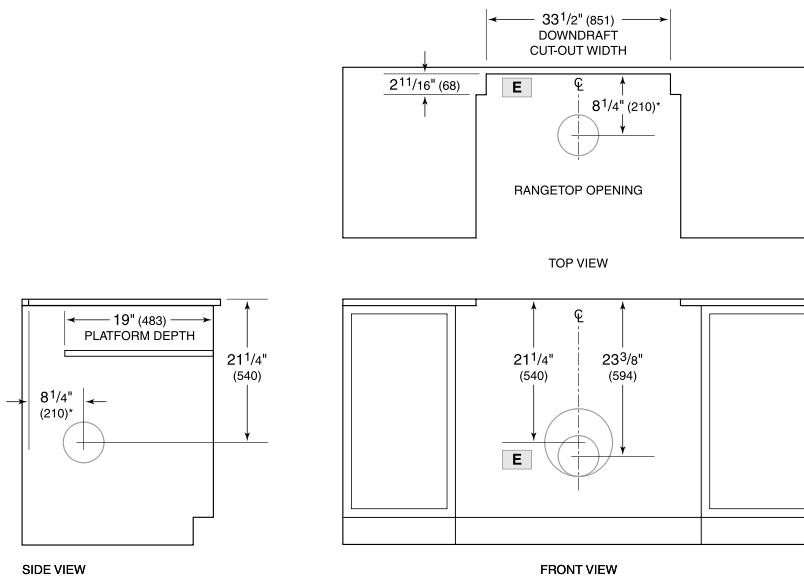

*6" (152) back from countertop cut-out when internal blower is rear mounted.

NOTE: Internal blower 6" (152) round, side, rear or bottom discharge. In-line and remote blower 10" (254) round, rear discharge. Centerline indicates center of downdraft cut-out.